

BOVENAANZICHT

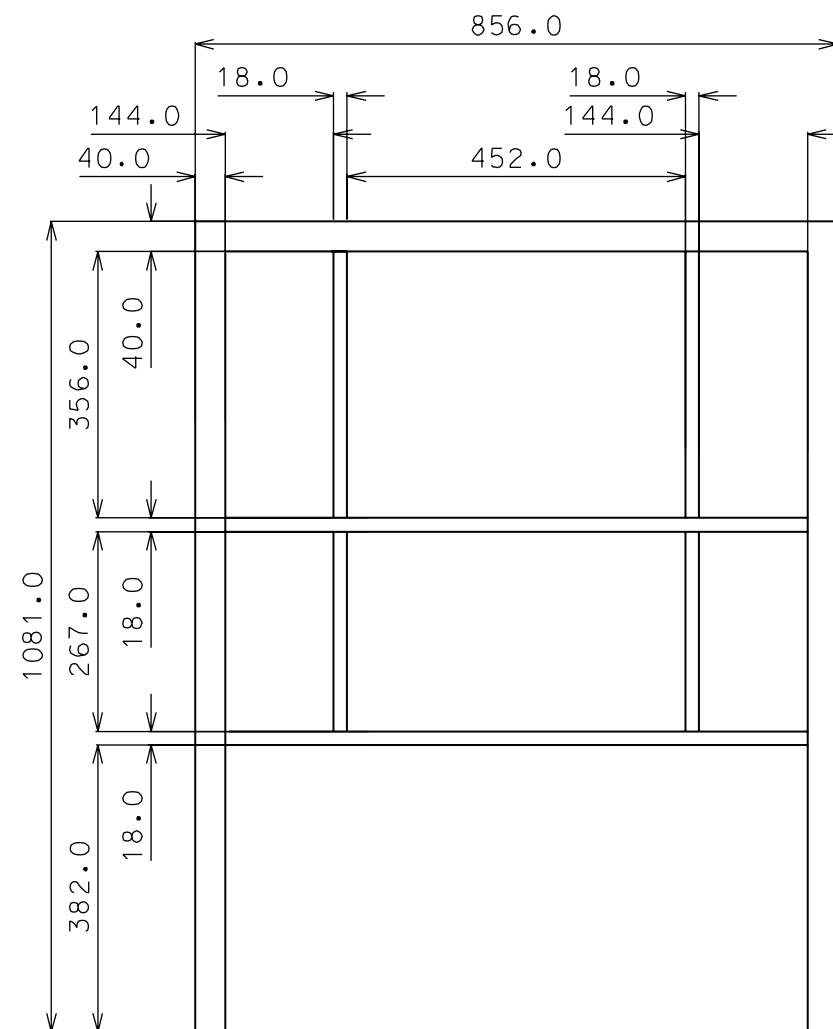

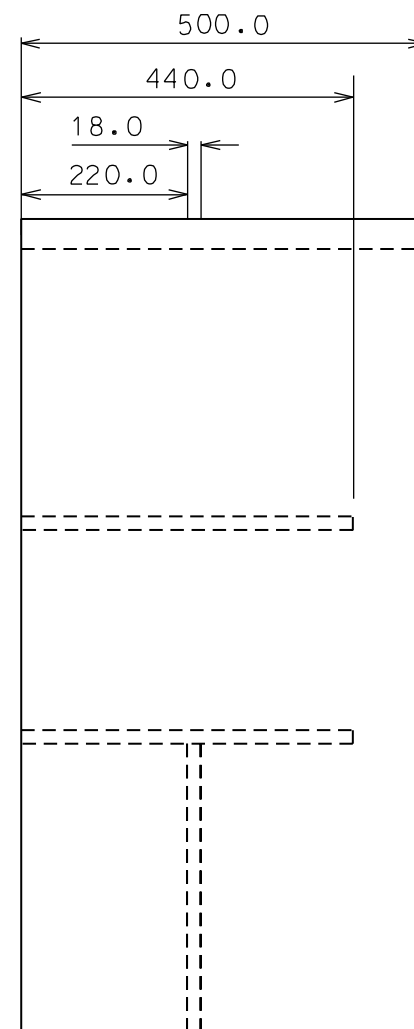





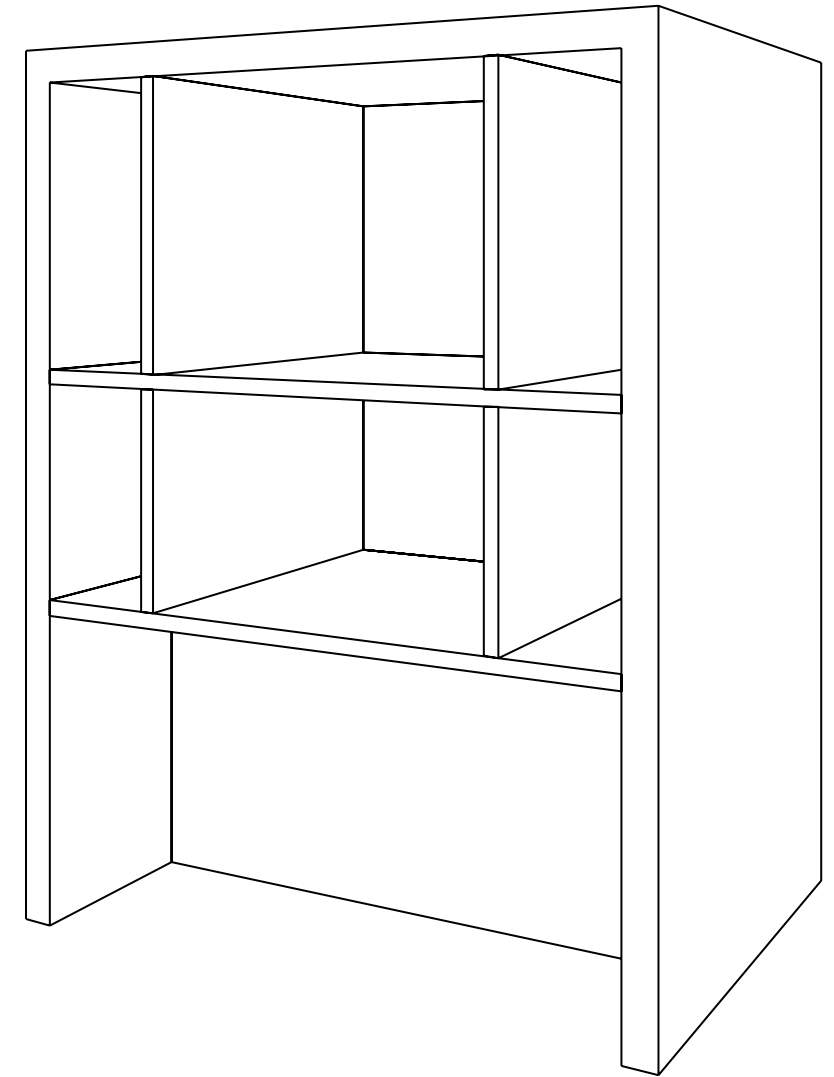





VOORAANZICHT



ZIJAAANZICHT



Laarhovendesign 

KLANT: 	KEMA	DATUM: 	01/08/2006
PROJECT: 	-	WIJZIGING: 	04/08/2006
	-		-
	-		-
PROJECTNR.: 	-	ONTWERPER: 	-
PROJECTLEIDER: 	H. van Bommel	SCHAAL: 	-
FILENAAM: 	-		

LAARHOVEN DESIGN INTERNATIONAL BV P.O. BOX 84 2350 AB LEIDERDORP THE NETHERLANDS
 (T) +31 (0)71 545 54 00 (F) +31 (0)71 545 54 97

INTELLECTUELE EIGENDOMSRECHTEN VOORBEHOUDEN